

# *Windham Weapony*

## **OPERATING & SAFETY MANUAL**

### **SEMI-AUTOMATIC SHOTGUNS**



**WARNING:** This product can expose you to chemicals including lead, which are known to the State of California to cause cancer and birth defects or other reproductive harm. For more information go to [www.p65Warnings.ca.gov](http://www.p65Warnings.ca.gov).

**READ THE INSTRUCTIONS AND WARNINGS IN  
THIS MANUAL BEFORE USING THIS SHOTGUN!**

## INDEX

---

1. SAFETY RULES
2. NOMENCLATURE
3. INITIAL ASSEMBLY AND INSPECTING
4. SAFETY BUTTON
5. LOADING AND USAGE
6. UNLOADING
7. DISASSEMBLY
8. REASSEMBLY
9. LOP SPACERS
10. ADJUSTABLE STOCK
11. ADJUSTABLE COMB STOCK
12. USE OF CHOKE TUBES
13. PARTS LIST
14. EXPLODED VIEW
15. CLEANING AND MAINTENANCE

BECAUSE OF THE TRAPPED MOISTURE THAT MAY CAUSE RUSTING IT IS NOT ADVISABLE TO STORE YOUR SHOTGUN IN A CARRY CASE.

## 1-SAFETY RULES

**WARNING: THE FAILURE TO FOLLOW THESE SHOTGUN SAFETY REQUIREMENTS WILL CAUSE SERIOUS PERSONAL INJURY OR DEATH TO YOU OR OTHERS.**

- ALWAYS TREAT A FIREARM AS IF IT WERE LOADED. NEVER ASSUME THAT IT IS UNLOADED.
- NEVER POINT THE FIREARM AT SOMETHING THAT IS NOT SAFE TO SHOOT.
- ALWAYS STORE FIREARMS TO PREVENT CHILDREN FROM HAVING ACCESS TO THEM. IT IS YOUR RESPONSIBILITY TO INSURE THAT UNAUTHORIZED PERSONS DO NOT GAIN ACCESS TO YOUR FIREARM. TO REDUCE THE RISK OF ACCIDENTS INVOLVING CHILDREN, UNLOAD YOUR FIREARM, LOCK IT AND STORE THE AMMUNITION IN A SEPARATE LOCKED LOCATION.
- ALWAYS WEAR ADEQUATE AND PROPER EAR PROTECTION.
- ALWAYS WEAR SAFETY PROTECTIVE GLASSES SPECIFIED FOR FIREARM USE.
- ALWAYS BE ALERT AND ALWAYS FOLLOW THE SAFETY INSTRUCTIONS OF THE RANGE OFFICER. NEVER SHOOT IF YOU ARE TIRED, COLD OR IMPAIRED IN ANY WAY.
- ALWAYS BE AWARE OF YOUR SURROUNDINGS, AND BE ALERT THAT PEOPLE CAN WALK INTO YOUR LINE OF FIRE.
- THE SHOOTER (AND ALL OTHERS IN THE SHOOTING AREA) MUST ALWAYS BE IN A POSITION THAT IS OUT OF THE LINE OF FIRE.
- NEVER SHOOT AT HARD SURFACES, WATER OR RANDOMLY INTO THE SKY. ALWAYS SELECT A PLACE TO SHOOT THAT HAS A SAFE BACKSTOP AND IS FREE FROM OBSTRUCTIONS AND WATER SURFACES WHICH CAUSE RICOCHETS.
- NEVER CLIMB A TREE, FENCE OR OBSTRUCTION WITH A LOADED FIREARM. OPEN AND EMPTY THE CHAMBER OF YOUR FIREARM AND ENGAGE THE MANUAL SAFETY BEFORE CLIMBING OR DESCENDING A TREE OR BEFORE CLIMBING A FENCE OR JUMPING OVER A DITCH OR OBSTRUCTION.
- NEVER TRANSPORT A LOADED FIREARM.
- NEVER USE ALCOHOL OR DRUGS BEFORE OR WHILE SHOOTING OR HANDLING ANY FIREARM.

### **NOTICE**

Discharging firearms in poorly ventilated areas, cleaning firearms, or handling ammunition may result in exposure to lead and other substances known to the State of California to cause birth defects, reproductive harm, and other serious physical injury. Have adequate ventilation at all times. Wash hands thoroughly after exposure.

## 2-NOMENCLATURE

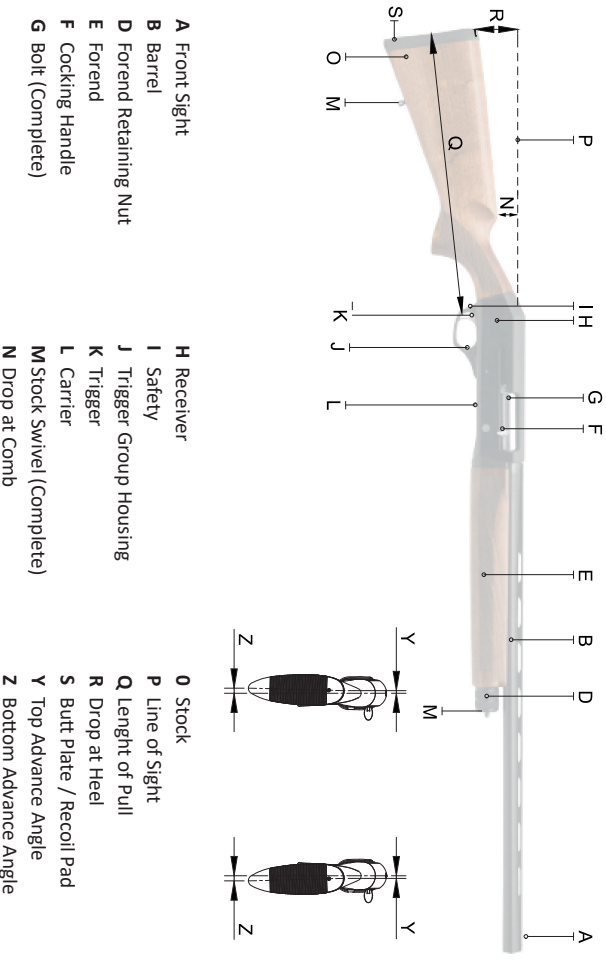

### 3-INITIAL ASSEMBLY AND INSPECTING

- Your shotgun is shipped from the factory with the barrel not assembled to the receiver (Figure 1).



Figure 1

- Unscrew the forend retaining nut (Figure 2) and remove the forend (when available, the forend extension first) by pulling it forward (Figure 3).

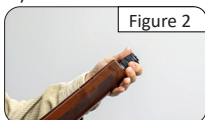

Figure 2



Figure 3

- Next, assemble the barrel to the receiver (Figure 4). When doing this you might need to gently pull/release the cocking handle for easier fitting. Assemble the forend (and forend extension when available) (Figure 5), and then screw the forend retaining nut (Figure 6).



Figure 4



Figure 5

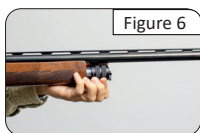

Figure 6

### 4-SAFETY BUTTON

The safety is designed to stop the trigger mechanism.

The safety on any gun is a mechanical device, and it is not intended as a substitute for common sense or safe gun handling. Always keep the muzzle pointed in a safe direction.

The safety is located behind the trigger, and provides protection against accidental or unintentional discharge under normal usage when properly engaged.

- To engage the safety, push the button from the left side so that it protrudes from the right side of the gun and the RED RING CAN NOT BE SEEN (Figure 7). The safe should always be in the "on" or "safe" position until you intend to fire the gun.
- When you are ready to fire the gun, press the safety button to the "off" or "fire" position, so that the safety protrudes from the left side of the shotgun and the RED RING APPEARS (Figure 8).

**WARNING: The gun will fire when the trigger is pulled intentionally or accidentally when the RED RING APPEARS.**



Figure 7

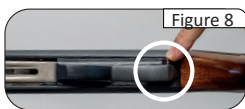

Figure 8

## 5-LOADING AND USAGE

**WARNING: WHILE LOADING, KEEP THE SAFETY "ON" AT ALL TIMES AND KEEP THE MUZZLE POINTED IN A SAFE DIRECTION.**

To load your semi-automatic shotgun, pull the cocking handle backward till it is locked (Figure 9) and press the bolt release button (Figure 10). Looking at the bottom of the gun, you will see that it is possible to move the carrier upward into the receiver. You can now insert shells into the magazine tube using your thumb (Figure 11). To chamber a shell when you are done with loading, push the shell drop lever located at the side of the of the carrier (Figure 12), and pull the cocking handle backward and a shell will come out of the magazine tube moving into the chamber with the support of the carrier (Figure 13). When you pull and release the cocking handle, the first round will get chambered and you are ready to fire. As the first shell is chambered, you can add one more shell into the magazine tube.

**WARNING: To prevent unexpected ignition and potential injuries, be certain that each round you use is in the proper gauge!**

**Always keep your fingers away from the trigger while loading and unloading your gun!**



Figure 9



Figure 10



Figure 11



Figure 12



Figure 13

## 6-UNLOADING

**WARNING: WHILE UNLOADING, KEEP THE SAFETY "ON" AT ALL TIMES AND KEEP THE MUZZLE AIMING AT A SAFE DIRECTION.**

Push the bolt release button and the carrier simultaneously. You will see that the shells will be ejected from the magazine tube (Figure 14). When all the shells are ejected, check the chamber by pulling the cocking handle backwards so that any shell in the chamber will be ejected (Figure 15).

Always keep your fingers away from the trigger while loading and unloading your gun.

**Always keep your fingers away from the trigger while loading your gun.**



Figure 14



Figure 15

## 7-DISASSEMBLY

- Unscrew the forend retaining nut (Figure 16), and remove the forend (Figure 17). Take the barrel off by pulling it forward (Figure 18).

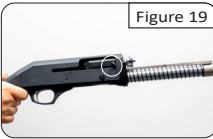
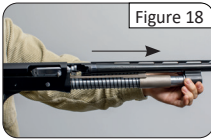

- To remove the charging handle, you must remove the barrel first and make sure the charging handle reaches the machined slot at the bottom right-hand side of the ejection port (Figure 19). Simply rotate it clockwise (Figure 20) and remove it from the bolt assembly (Figure 21).

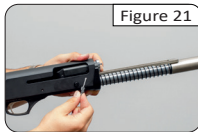

- Next take the bolt assembly, action bar and recoil spring out of the receiver assembly (Figure 22&23).

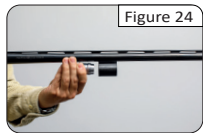
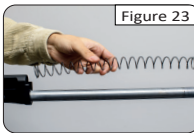
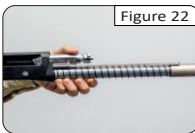

- Take the gas piston located in the gas chamber out that is under the barrel by pulling it with your fingernails (Figure 24). Using a tool (if necessary, a soft head hammer) remove the pin (Figure 25) and take the trigger group housing out (Figure 26).

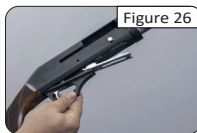

*\* Note that you must remove the barrel clamp on the tactical models first to be able to disassemble your shotgun*

## 8-REASSEMBLY

- To reassemble your shotgun, do each step explained in disassembly section in reverse order. Before putting the trigger group housing into its place, make sure that the hammer is cocked. Figure 27 shows the cocked state, and Figure 28 shows the decocked state of the hammer.



Figure 27



Figure 28

## 9- ADJUSTING LENGTH OF PULL (LOP SPACERS)

- You can extend the length of pull by placing LOP spacers between the buttpad and the stock. Your shotgun is provided with 3 pieces of 5 mm (0.2") LOP spacers.
- To adjust the length of pull of your shotgun, first remove the two screws located on the top and bottom of the buttpad using a screwdriver (Figure 29).
- The length of pull is the distance from the center of the trigger to the butt of the recoil pad.
- To achieve the desired length of pull, arrange the LOP spacers as shown in Figure 30.



Figure 29



Figure 30

- After placing the LOP spacers, attach the recoil pad to the stock (Figure 31) and tighten the screws using a screwdriver in the opposite direction of how they were removed (Figure 32). To prevent wear on the buttpad and make the process smoother, it is recommended that the screwdriver tip be slightly greasy.



Figure 31



Figure 32

## 10-ADJUSTABLE STOCK

- Each shotgun is provided with a set of stock shims to assist the shooter in obtaining a personalized fit to the sighting plane. The stock is user adjustable for either cast or stock drop. This adjustment is made by replacing the plastic shim located between the receiver and the stock (Figure 33). Note that only one shim can be inserted between stock & receiver.



Figure 33



Figure 34

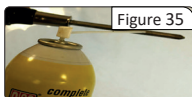

Figure 35

- The factory installed shim is marked CIP which provides a neutral cast and standard drop dimensions of the comb. The shim kit includes two replacement shims that change the cast of the stock, either Left 5 or Right 5. These spacers do not affect the stock drop.
- The kit includes three replacement shims that change the drop of the stock. The slope of the drop in the stock can be changed from standard to -10, or -5 or a positive 5 direction.
- Replacing the stock shim requires the removal of the butt pad. The butt pad is attached by two Philips head screws. To detach the pad;
- Locate the screws on the pad (Figure 34).
- Lubricate the shaft of the screw driver to prevent damaging the rubber pad (Figure 35).
- Once the pad is removed, loosen and remove the stock bolt and its washer using a wrench (Figure 36), and pull the stock free from the receiver (Figure 37). Note that it is not necessary to remove both of the screws on the pad; you may unscrew one of them and pivot the pad to gain access to the bolt.

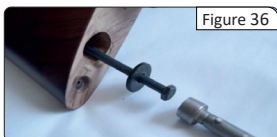

Figure 36



Figure 37

- Remove and replace the shim for a personalized stock fit (Figure 38), and re-attach the stock and tighten the stock bolt (Figure 39).
- Re-attach the butt pad with lubricated screw driver (Figure 40).



Figure 38



Figure 39

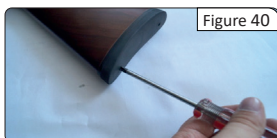
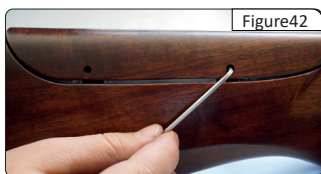

Figure 40

## 11-ADJUSTABLE COMB STOCK

- The point of impact of the shotgun can be adjusted by moving the comb of the stock. The comb hardware can be adjusted both horizontally and vertically, allowing the shooter to personalize the fit of the shotgun stock.
- To adjust the comb, loosen the two set screws on the side of the comb with the allen wrench (Figure 41).



- Lift the comb upward off the support posts (figure 42), and remove the washers from the posts.
- To adjust the horizontal alignment of the comb, loosen the screw in the top of the post with the allen wrench (Figure 43).
- Slide the post in the desired direction, and re-tighten post at desired location.
- Moving the post to the left will cause the shotgun to shoot to the left. A change of 1/16" in the comb position will cause a change in the point of impact of approximately 2" at 30 yards. The base plates are etched with 1/16" reference lines to aid the shooter in determining the amount of pattern movement when re-positioning the comb (Figure 44).

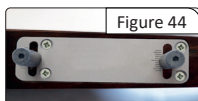
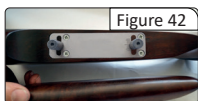





- Slide the washers over the posts to adjust the height of the comb.
- By raising the comb height with the washers, the shotgun will shoot a higher point of impact. The washer thickness is approximately 1/16" and each washer will move the impact point upward approximately 1 1/2 inches at 30 yards (Figure 45).
- After you have made your desired adjustment, place comb over the posts and tighten the two set screws in the side of the comb with the allen wrench (Figure 46).



## 12-USE OF CHOKE TUBES

With the choke tubes you can controls the openness or tightness of the pattern of your shotgun. The chart below lists the chokes available (from open to tight), and the corresponding marks that indicate the choke of your shotgun.

AMERICAN DESIGNATION	CL (Cylinder)	IC (Improved Cylinder)	M (Modified)	IM (Improved Modified)	F (Full)
CHOKE TUBE					
NOTCHES	★★★★★	★★★★	★★★	★★	★
COMPATIBILITY WITH SLUGS	Recommended	Not Recommended	Not Recommended	Not Recommended	Not Recommended
COMPATIBILITY WITH STEEL SHOT	Recommended	Recommended	Recommended	Not Recommended	Not Recommended
BEST IN THE AREA OF	Sporting, clay and skeet shooting. Short distance, more open shooting.	Quail, dove and target shooting. For shorter distance more open shooting.	Hunting woodcock, pheasant & quail with 30-35 yard shots. Long range hunting with steel shot and tight groups.	For hunting pheasant, ducks with 30-40 yard shots.	For duck and goose hunting with 40-45 yard shots. For long range hunting with lead shot and tight groups.

\* All choke tubes are included in the package in a specially designed box.



**WARNING:** When installing a choke tube in your barrel, make sure that the tube is completely screwed down tight in the barrel, never shoot your shotgun without the choke tubes installed as this may damage the barrel and injure the shooter. Choke tubes may become loose after extended firing and should be checked frequently for tightness.

## 12-USE OF CHOKE TUBES

### INSTALLATION OF CHOKE TUBES

**WARNING:** Check that the firearm is unloaded. If not, unload the firearm by operating as described in the chapter “Unloading”. Never look into the muzzle or change tube on a loaded gun; even with safety is set to “ON”.

- Apply a thin coat of gun oil to the threads of the barrel and of the choke tube.
- Insert the desired chokes into the choke housing. Take care the notched end will be upside.
- Carefully hand screw the chokes into the barrels clockwise (Figure 47). Using the choke tube Wrench; tighten the choke until it is fully bottomed into its recess in the barrel.
- Remove the choke tube wrench after tightening.



### REMOVAL OF CHOKE TUBES

**WARNING:** Check that the firearm is unloaded. If not, unload the firearm by operating as described in the chapter “Unloading”. Never look into the muzzle or change tube on a loaded gun, even with safety engaged.

- Unscrew (counterclockwise) the choke tube using the choke tube wrench supplied (Figure 48). Remove the choke tube from the muzzle (Figure 49).

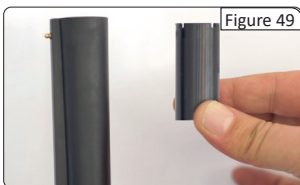
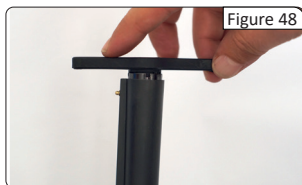

### CLEANING OF CHOKE TUBES

**WARNING:** Check that the firearm is unloaded. If not, unload the firearm by operating as described in the chapter “Unloading”. Never look into the muzzle or change tube on a loaded gun, even with safety is set to “ON”.

- Carefully clean the choke housing. If necessary, use a cotton patch coated with gun oil.
- Check the choke to make sure it is perfectly clean inside and outside.
- Apply a thin coat of gun oil to the threads of the barrel and of the choke tube.

## 13-PARTS LIST

1	Receiver	40-A	Shell Ejector Spring
3	Magazine Tube	40-B	Ejector Rivet (Short)
4	Rear Magazine Plug	40-C	Shell Ejector Retaining Pin
5	Magazine Spring	41	Piston
6	Front Magazine Plug	42	Barrel Ratchet Pin
7	Recoil Spring	43	Forend
8	Stock Retaining Nut	44-A	Barrel
9	Stock	44-B	Barrel (Tactical)
9-B	Shim	47	Forend Retaining Nut Spring
9-C	Adjustable Comb Stock	48	Forend Retaining Nut
10	Stock Washer	49	Safety
11	Picatinny Rail	50	Safety Spring Guide
11-A	Picatinny Rail Retaining Screws(2 Pieces)	51	Safety Spring
12	Through Bolt	52	Safety Spring Pin
13	Recoil Pad	53	Trigger
13A	LOP Spacer	54	Disconnecter Spring
14	Butt Screw (2 Pieces)	55	Disconnecter Spring Pin
18	Bolt Release Button Spring	56	Disconnecter
19	Bolt Release Button	57	Disconnecter Pin
20	Bolt Release Button Pin	58	Trigger Spring
21	Carrier Lock Spring	59	Trigger Stop Pin
22	Carrier Lock	60	Trigger Pin
23	Carrier Lock Pin	61	Carrier Lever
24	Cocking Handle Bearing Pin	62	Carrier
25	Cocking Handle Bearing Spring Barrel Ring Ratchet Spring	63	Carrier Lever Rivet
26	Cocking Handle Bearing Screw Barrel Ring Ratchet Screw	64	Hammer Spring
27	Extractor Spring	65	Hammer Spring Guide
28	Extractor	66	Hammer
29	Extractor Retaining Pin	67	Hammer Retaining Pin
30	Locking Block	68	Retaining Circlip
31	Locking Block Spring	69	Shell Drop Lever Spring
32	Firing Pin Spring	70	Shell Drop Lever
33	Firing Pin	71	Shell Drop Lever Retaining Pin
34	Firing Pin Screw	72	Carrier Lever Spring
35	Follower Pin	73	Carrier Lever Spring Pin
36	Bolt	74	Trigger Group Housing
37	Action Bar	75	Trigger Group Retaining Pin
38	Cocking Handle	76	Front Sight
39	Ejector	77	Choke Tube
40	Ejector Rivet (Long)	79	Hammer Stopper
		80	Forend Retainer
		80-A	Forend Retainer Ring Nut

# 14-EXPLODED VIEW

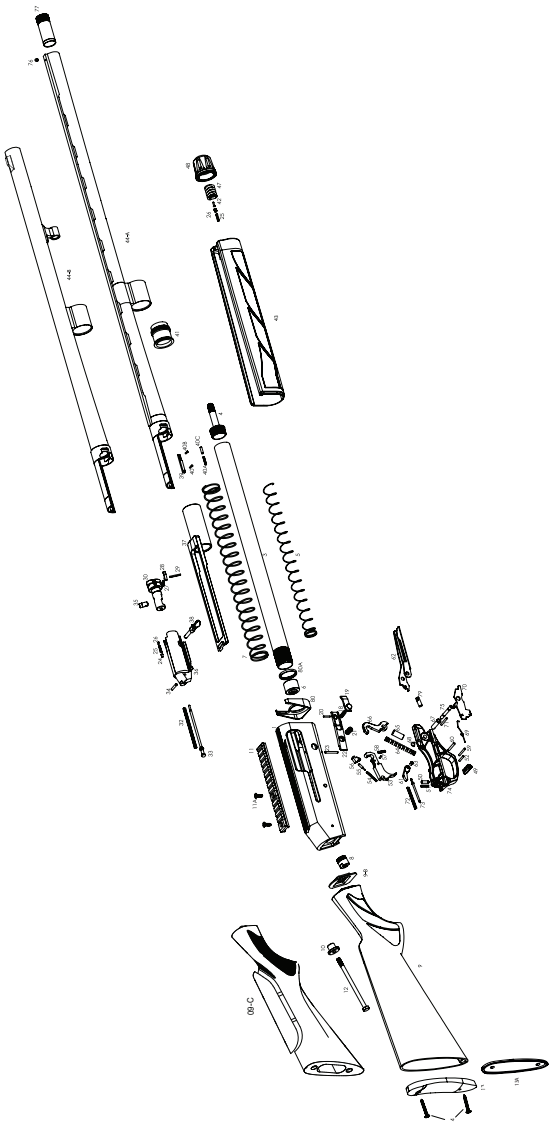

## 15-CLEANING AND MAINTENANCE

**WARNING: ENSURE THAT YOUR FIREARM IS UNLOADED BEFORE BEGINNING TO CLEAN IT.**

At the end of the day of shooting/hunting, clean and lubricate the shotgun.

**Cleaning procedure:**

**Check and regularly clean the gas piston, gas chamber and 2 gas ports inside the gas chamber; otherwise your gun may fail to cycle.**

- Disassemble the shotgun (see paragraph "Disassembly").
- Clean the bores with care by passing a cleaning rod with a cotton patch coated with a high-quality gun oil to remove combustion residues. Also include the chambers in your cleaning operation.
- Do not forget to clean choke tubes (if available) and choke seats in the muzzle. Failure to clean these areas will result in the inability to remove the choke from the barrel and severe damage to the muzzle. If a choke tube becomes tight in the muzzle, this is an indication that the thread requires cleaning.
- Run a clean dry patch through the bores to remove oil residues.
- Lightly oil the inside of the barrels with a clean cotton patch coated in high-quality gun oil.
- Clean with care the external surfaces of the shotgun to remove any trace of dirt, sweat and fingerprints.
- Make sure you do not touch the metal parts while you are putting your shotgun back into its place of storage.

Always follow the instructions provided with your gun cleaner and gun lubricant.

Whenever your firearm has been exposed to sand, dust, extreme humidity water or other adverse conditions, it must be cleaned and lubricated.

After an intensive period of use, check the operation of the bolt assembly and if necessary, clean and lubricate it using suitable gun oil.

If your firearm seats used in a cold climate, be sure to use an oil of an appropriate weight so that it will not congeal in cold temperatures.

**NEVER MANIPULATE, ADJUST OR CHANGE ANY OF THE INTERNAL COMPONENTS OF YOUR FIREARM.**

**ANY MAINTENANCE, ADJUSTMENT OR SERVICE NOT SPECIFIED IN THIS MANUAL MAY AFFECT THE SAFETY AND RELIABILITY OF YOUR FIREARM AND MUST BE PERFORMED BY AN AUTHORIZED GUN-SMITH USING GENUINE FACTORY PARTS. IF YOU DO OTHERWISE, IMPROPER FUNCTIONING OF YOUR FIREARM MAY OCCUR AND SERIOUS INJURY OR DEATH MAY RESULT.**

When storing, do not encase the shotgun in anything that will attract or hold moisture, for example; leather or heavy cloth. Also, do not store shotguns with a plug inserted in the barrel for this can be a contributing factor to moisture accumulation. If the shotgun is to be stored for an extended period, the bore, chamber and internal surfaces should be oiled with a high-quality lubricating oil preservative intended for firearms.

The external parts; receiver, bolt and barrel should be coated with an anti-rust oil.

# Windham Weaponry



Rev : WW01-050925